



# UNITRUNK

## PRODUCT GUIDE V5

60

YEARS OF EXCELLENCE

UNITRUNK



# Celebrating **60 Years** of Excellence



“ As Unitrunk enters its 60th year in business, I’m very excited to bring you our latest Product Guide. I’m confident you will find everything you need inside to complete your next cable management project on time, and within budget.

*We’ve added new and innovative products to our range, designed specifically to make your cable management installation process easier than ever, while saving you time and money onsite.*

*Get in touch with the Unitrunk team to discuss our extensive product range, ask for technical advice or to enquire about a bespoke solution for your next project.*

*With more staff and locations than ever, we’re more than ready to continue supplying your cable management projects for the next 60 years and beyond!* ”

David Morrow  
Managing Director  
Unitrunk



<b>1</b>	QuickFix Trunking Systems	26 - 31	QuickFix Trunking
<b>2</b>	QuickFix Multi-Compartment Trunking Systems	32 - 37	QuickFix Multi-Compartment Trunking
<b>3</b>	Lighting Trunking Systems	38 - 41	Lighting Trunking
<b>4</b>	Uniklip® Cable Tray Systems 42 - 57	Cable Tray Systems 58 - 71	Uniklip Cable Tray
<b>5</b>	Speedway® Cable Ladder Systems 72 - 79	Speedway® Pre-Galv. Cable Ladder Systems 80 - 87	Speedway Cable Ladder Pre-Galv. Cable Ladder
<b>6</b>	Cable Basket Systems	88 - 97	Cable Basket Systems
<b>7</b>	Channel & Support Systems	98 - 107	Channel & Support
<b>8</b>	Floor Trunking Systems	108 - 123	Floor Trunking
<b>9</b>	Bench Outlet & Perimeter Trunking	124 - 131	Bench Outlet & Perimeter Trunking
<b>10</b>	Steel Conduit (Class 4)	132 - 133	Steel Conduit [Class 4]
<b>11</b>	Innovative Design Solutions	134 - 137	Innovative Design Solutions
<b>12</b>	Accessories & Supports	138 - 141	Accessories & Supports
	Index	142 - 144	Index

# GLOBAL EXPERTISE

We are committed to adding value with the highest levels of service and support, along with an innovative range of standard and bespoke cable management solutions.

We are experienced in dealing with operators, engineers and design houses, and understand the challenges of operating in a global marketplace. From consolidating and shipping vast quantities of materials around the world, to providing information to product inspectors and having the know-how to complete the detailed documents required to support international shipments, we are prepared to meet the demands of your project.

Thanks to our worldwide network of partners in key strategic locations including Australia, Belgium, Brazil, Cyprus, Denmark, France, Germany, Ghana, Indonesia, Italy, Ireland, Kazakhstan, Korea, Malaysia, Netherlands, Russia, Singapore, Thailand, UAE, UK, USA and Vietnam, we deliver proven cable management solutions of the highest quality, on time and to major projects all over the world.







# QuickFix

Introducing QuickFix, the innovative trunking system designed to save time onsite, thanks to its quick and easy to install design.



### UniBolt Fixings

Fast-fitting UniBolt reduces installation times by up to 80%



### IP4X Compliant

Compliant as standard.  
Easy to assemble system



### Complete Range

Innovative, rapid installation cable management systems

# UP TO **6X FASTER** CABLE TRUNKING INSTALLATION

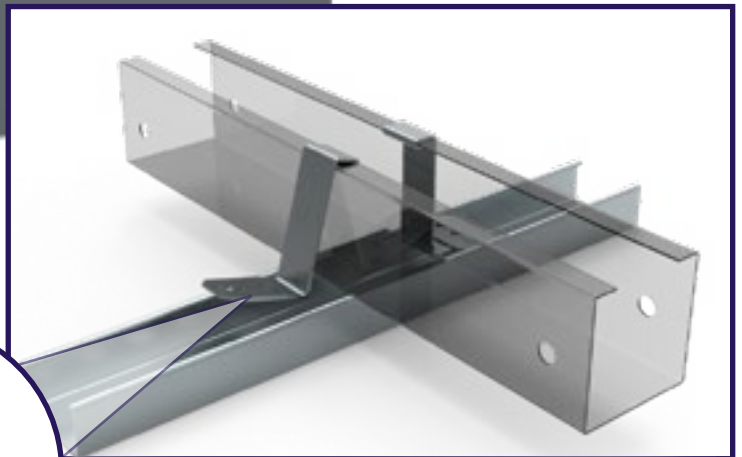

## Now available

The **small** bracket making  
a **BIG** impact!

Secure trunking to  
channel in seconds!

Part Code: TKHDB

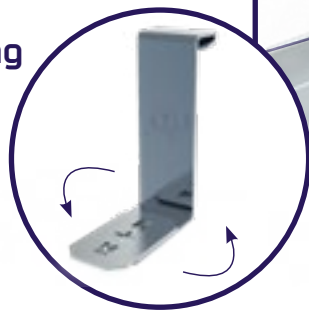

SCAN HERE

to check out the time saving  
simplicity for yourself





**VANTRUNK**





# WELCOME TO OUR **EXTREME** CABLE MANAGEMENT DIVISION

Unitrunk's specialist division, Vantrunk, is internationally renowned for its cable management products and associated support systems specifically designed for extreme conditions. Their trusted and innovative solutions have been serving the Global Energy, Oil and Gas and Industrial Processing sector for over 60 years with cable management systems designed to thrive in extreme environments.

Visit the Vantrunk website to explore the complete range of cable management solutions.

**vantrunk.com**





# THE PATENTED, REVOLUTIONARY **KLIP** SYSTEM **FOR CABLE TRAY**

**‘KLIP’  
& GO!**

Still spending too much time cutting, screwing and tightening components at every stage of the job?

Try **UNIKLIP®**, the simple innovation which could save you a LOT of time and money on your next cable tray installation!

Installers have been finishing jobs at least **3X faster** and **saving up to 50%** on overall costs, isn't it time you were too?

**The same trusted Unitrunk strength and quality - just faster and easier to install.**



Load tested to BS EN 61537 standards.  
PATENTED: UK Patent Number: GB2476569, Ireland Patent Number: 086566

**3X**  
**FASTER**

**THAN**  
**STANDARD**  
**INSTALLATION**

UNIKLIP®'s patented design makes cable tray quick and easy to install.  
Simply "klip" securely into place as required.

Strong, reliable and load tested to BS EN 61537 Standards.

Make the switch and start saving today.

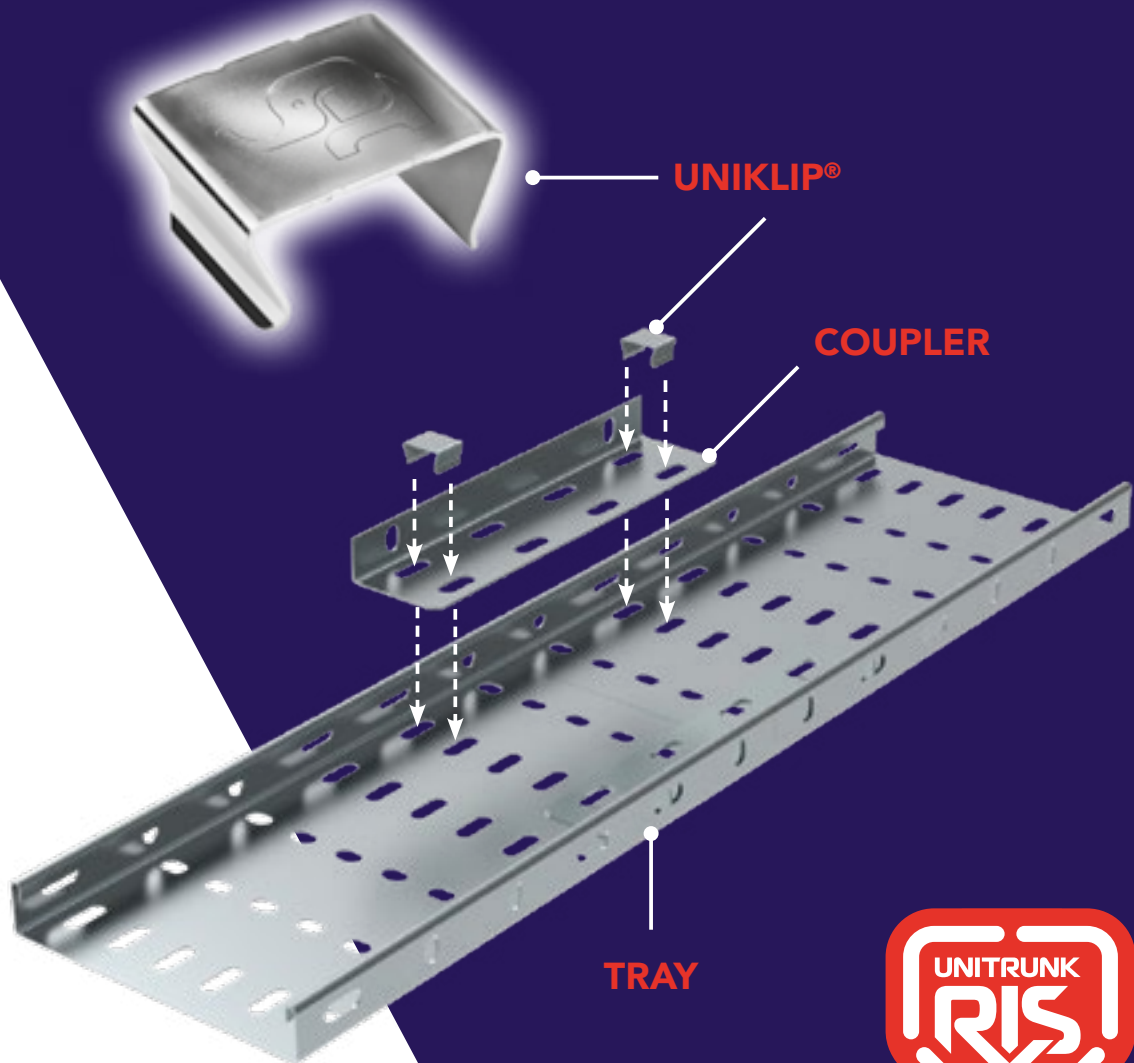

COUPLERS & FITTINGS ARE  
SUPPLIED WITH UNIKLIPS®



# QUALITY & STRENGTH YOU CAN TRUST

We harness the power safely, giving you the confidence that our products meet, and surpass, all relevant standards through our in-house manufacturing to ISO 9001: 2015 and CE Accreditation. We have also successfully achieved ISO 14001:2015 Environmental accreditation as well as ISO 45001:2018 Health & Safety accreditation.

These three elements make up our Business Management System which we use to drive continuous improvement and integrate our consistent best practices throughout the group. Unitrunk holds the Achilles TransQ accreditation (certificate no. 22992), UVDB accreditation (certificate no. 092618) and the RISQS accreditation for the rail industry (certificate no. 2481).

**BS EN 10346: 2015**

Ref: Pre-galvanised steel

**BS EN ISO 1461: 2009**

Ref: Post galvanised products

**BS EN 50085-1: 2005**

**BS EN 50085-2-1: 2006**

Ref: Cable trunking and ducting systems

**BS EN 6946: 1988**

Ref: Metal Channel Cable Support Systems for electrical installations

**BS EN 50085-2-2: 2008**

Ref: Under floor, flush floor or on floor

**BS EN 60529: 1992**

Ref: Weatherproof trunking

**BS EN 61537: 2007**

Ref: Cable tray, cable ladder and cable basket

**BS6399 PART 1: 1996**

Ref: Easyway flush floor trunking

**BS EN 10088-2: 2005**

Ref: Stainless steel material

**BS EN 10130: 2006**

Ref: CR4 material

*NB. The above details are correct at time of print but are subject to revision in line with industry reviews.*

## QUALITY MARKS:





# RECOGNITION OF OUR QUALITY



ISO 9001, 14001 & 45001

9235



## PRODUCTS & MATERIALS

Applies to our Cable Basket range



## ACCREDITATIONS



### Accredited to LUL Standards:

- Channel and Support Systems
- Cable Basket Tray
- Cable Ladder
- Lighting Trunking
- Standard and Multi Compartment Trunking

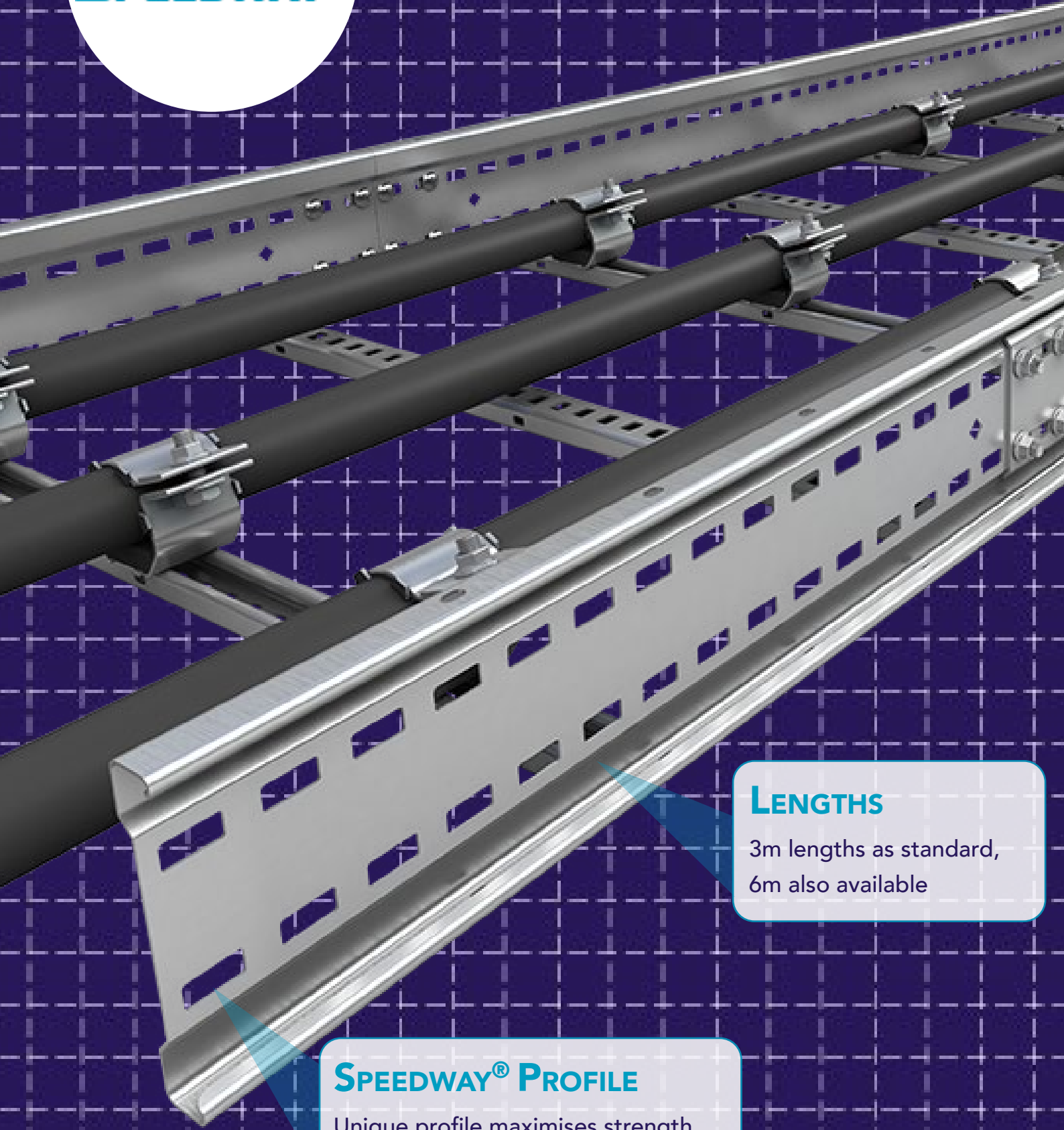

### LENGTHS

3m lengths as standard,  
6m also available

### SPEEDWAY® PROFILE

Unique profile maximises strength  
and increases internal load area

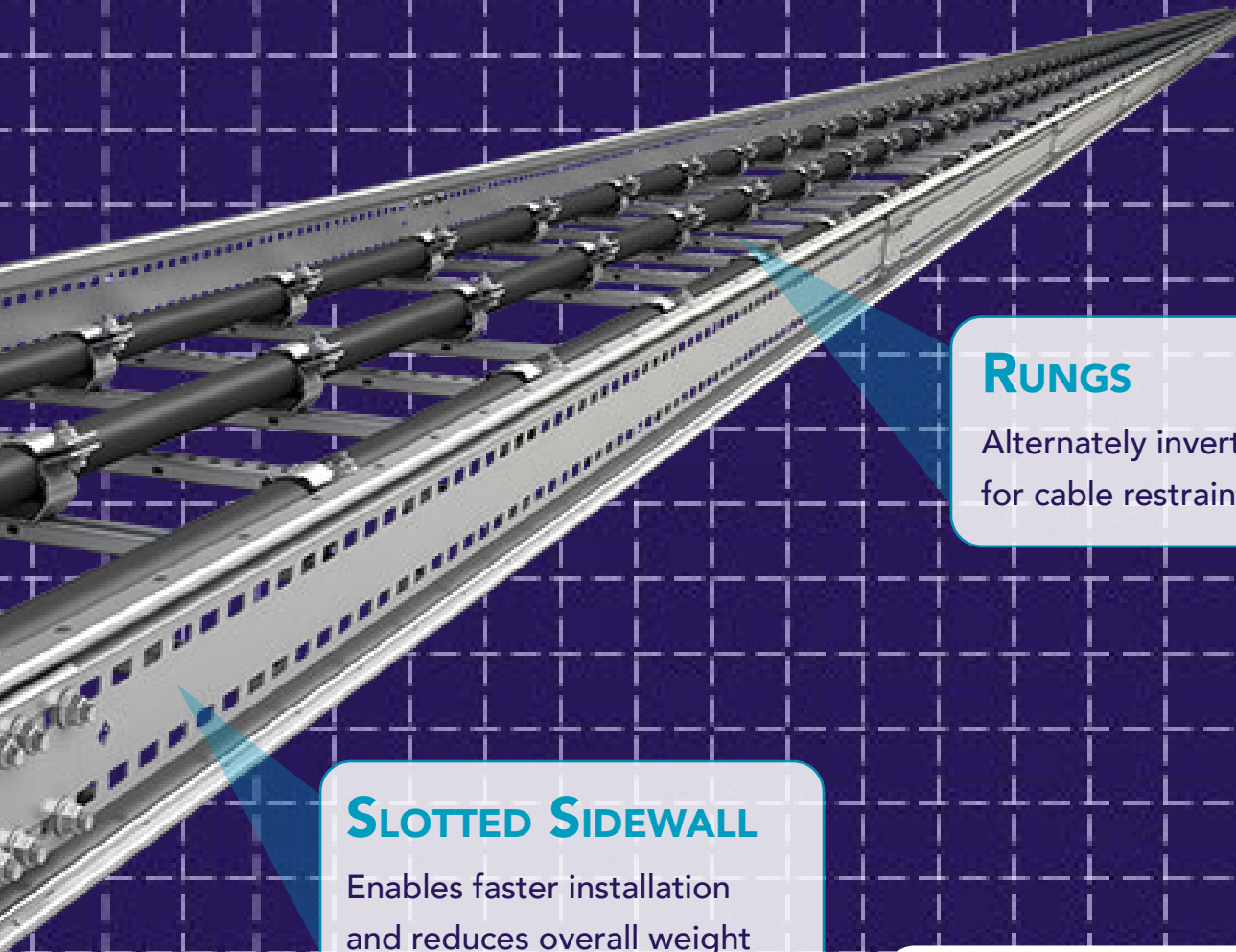

## RUNGS

Alternately inverted rungs for cable restraint flexibility

## SLOTTED SIDEWALL

Enables faster installation and reduces overall weight

## INTEGRAL COUPLER



Reduces installation time, weight and cost

**Speedway**<sup>®</sup> cable ladder system represents a major advance in cable ladder design, providing faster and easier installation, greater cable fill capacity and total flexibility.

**Speedway**<sup>®</sup> cable ladder system conforms to BS EN 61537.







# FACILITIES

Our 9300m<sup>2</sup> production site includes manufacturing and warehousing facilities and additional marshalling and storage areas, ideal for major projects.

Unitrunk Group resources and facilities include Vantrunk's 10,000m<sup>2</sup> purpose-built production facility in Warrington, England. Both sites are equipped with state of the art industrial production and processing technology.

## Facilities include:

- R&D
- On site testing to industry standards
- Measurement
- Cutting edge production equipment
- Standards conformance

Please consult our Innovative Design Solutions section for more information about our bespoke products.

# EASYCONNECT® CABLE BASKET SYSTEMS

A strong, yet flexible, solution designed to meet the demands of the power, data and systems cabling installed in modern buildings.

EasyConnect® Cable Basket system adheres to Unitrunk's RIS (Rapid Installation Systems) philosophy, the integral coupler simply pushes together to form a secure joint, no additional couplers or special tools are required.

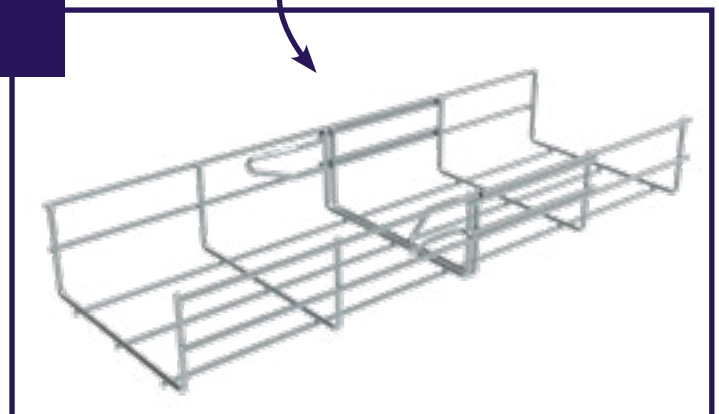
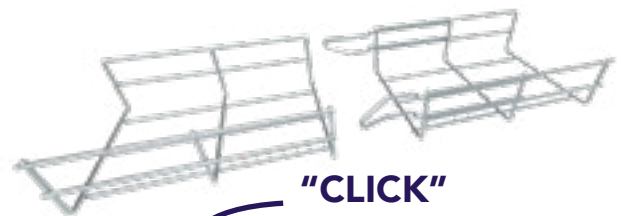

## EASYCONNECT® TECHNICAL DETAILS

- Overall length of 3000mm
- When two lengths are joined, joint proximity means that the combined length will be 6000mm (perfect for use in Modular (off-site) fabrication as this eliminates "basket creep" which can occur with other basket products)
- Manufactured to comply with BS EN 61537, load tested and meets earth continuity requirements of the standard
- Short circuit tested with a fire rating of E90.
- Patented and manufactured by Valdinox and distributed in the UK & Ireland exclusively via Unitrunk

ACCREDITED TO THE FOLLOWING STANDARDS



**EVERYTHING YOU NEED  
IN ONE BASKET:**

- ✓ **STRENGTH**
- ✓ **ADAPTABILITY**
- ✓ **SPEED**
- ✓ **EASE OF USE**

## **TIME SAVING SIMPLICITY**

Forget about hold down plates, spring nuts and bolts - this simple klip secures basket to channel in seconds!

For best results use with Unitrunk's Intelok channel. Intelok®'s serrated return flange provides maximum slip resistance under a side load/impact.

### **BASKET TO CHANNEL KLIP**



Part Code: UFC41M

# A SUSTAINABLE FOCUS FOR THE FUTURE

Sustainability has been a key element to innovation and design at Unitrunk from the beginning. Recently, we have taken a number of steps to further enhance our sustainable approach to business with the overall ambition to operate NetZero manufacturing facilities by 2030.

The installation of solar panels at our Lisburn manufacturing site produces over 100kWh/day on average annually.

Energy harvested by the panels provides enough power to operate our entire office and manufacturing facilities throughout the year, all while reducing our company's carbon emissions and contributing to a cleaner environment.

We will be installing solar panels across our entire depot network near year which will bring them to 70% to getting off-grid.

We have made the switch to energy efficient LED lighting throughout all office and factory buildings, at both our manufacturing sites and throughout our branch network, in a continued effort to consume less energy throughout the business as a whole.

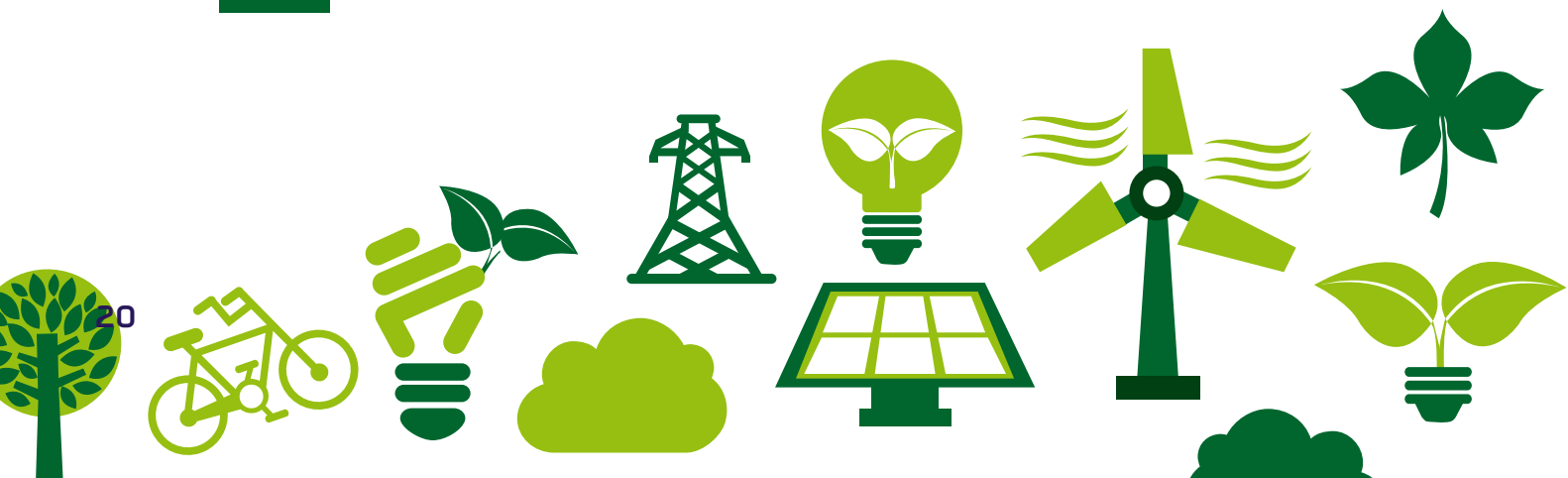



# AVAILABLE PRODUCT FINISHES



Pre-Galvanised



Galvanised After  
(Hot Dipped Galvanised)



Powder Coated



Electro Zinc



Galvanised After  
(Corten A Steel)



Stainless Steel 316



Stainless Steel 304  
(Marine Grade)

Questions about  
choosing the right  
material finish for  
your project?

## WE'RE HERE TO HELP:



**Email** [info@unitrunk.co.uk](mailto:info@unitrunk.co.uk)



**Call** your nearest Unitrunk  
location (see pg 25)

You can also view our complete product range online at

# THE **SPEEDWAY**<sup>®</sup> FAMILY IS GROWING!



The fast-fitting cable ladder system is now available in **Pre-Galvanised** steel, ensuring the best finish for your project, every time.



**AVAILABLE TO ORDER NOW**

# THERE WHERE YOU NEED US



World class cable management systems and service,  
delivered to you via our local distribution network.



---

We pride ourselves on our wide range of innovative cable management solutions made right here in the UK and Ireland.

With impressive manufacturing capabilities and a skilled Design and Innovation team, our product range continues to get bigger, better and stronger.

Our regional distribution network means you can rely on our supply and stock system to service your needs, from bespoke solutions to full scale contracts.

For projects further afield, our experienced Exports team will be happy to help.

---

## MANUFACTURING LOCATIONS:

### Lisburn (Head Office)

+44 (0) 28 9262 5100  
lisburn@unitrunk.co.uk

### Warrington (Vantrunk)

+44 (0) 1928 564 211  
sales@vantrunk.co.uk

## DEPOT LOCATIONS:

### Dublin

+353 (0) 8200 292  
dublin@unitrunk.ie

### Livingston

+44 (0) 1506 461 964  
livingston@unitrunk.co.uk

### Manchester

+44 (0) 161 336 1177  
manchester@unitrunk.co.uk

### Yorkshire

+44 (0) 113 512 2910  
yorkshire@unitrunk.co.uk

### Harlow

+44 (0) 1279 444 481  
harlow@unitrunk.co.uk

### Bristol

+44 (0) 1179 823 720  
bristol@unitrunk.co.uk

### North East

+44 (0) 1914 921 470  
northeast@unitrunk.co.uk

### Wolverhampton

+44 (0) 1902 717 786  
wolverhampton@unitrunk.co.uk